

# BENDING



Scalable-automation press brakes

salvagnini

# Change perspective, think results!

## PRODUCTIVITY

### How to make press brake productivity independent of batch size?

ATA/ATA-LT and ATA/MVM are proprietary Salvagnini automation solutions for tool management. They allow kit and batch-one production on press brakes, while keeping high productivity.

### How to make the machine independent of the operator?

AU-TO is Salvagnini's patented automatic upper and lower tool changer. It sets up the press brake, guaranteeing it complete independence and efficiency in applying the best strategies according to the production flow.

### How to reduce environmental impact while maximizing production?

The architecture and technical solutions adopted (Direct Drive and KERS) allow the B3 press brake to respect both people and the environment, without reducing productivity.

## ADAPTABILITY

### How to make production independent of material changes?

MAC2.0 is the set of adaptive technologies (S-CROWNING, AMS, TFC) embedded in the press brake. It makes the system intelligent, eliminating scrap and part correction, widening the range of products which can be produced.

### How to adapt the machine to production requirements?

Each B3 press brake offers extensive configurability: options and accessories facilitate operation and part handling, enhance the versatility of the press brake or improve its ergonomics (locking devices, backgauges, sheet followers).

## INTEGRABILITY

### How to integrate the press brake into the factory?

All B3 press brakes can be equipped with the OPS process software, which enables communication between the machine and the company ERP. They are also ready to be connected to LINKS, the IoT solution for condition monitoring.

### How to automatize bending?

Thanks to their extensive expertise in systems and automation, and wide application experience in sheet metal processing, Salvagnini's specialists are able to help the customer to choose the best solution, whether it be a stand-alone press brake, a robotized bending cell (ROBOformER), a flexible bending cell (FlexCell) or an automatic factory (AJS).



Thanks to Salvagnini's unique solutions, the press brake can adapt itself in setting up and managing the tools on the basis of what it needs to produce. Adopting scalable and modular automation in bending means significant improvements in machine availability, extending its independence and flexibility.

# B3, the ideal press brake for dynamic production.



## Sustainable productivity

The technical solutions adopted (Direct Drive and KERS) allow it to **respect both people and the environment**, without reducing productivity. The architecture increases the machine's versatility, relaxing part geometry constraints.



## Adaptive technology

The integrated adaptive technologies (S-CROWNING, AMS, TFC) make the system intelligent, **eliminate scrap and part correction**, and expand the range of products which can be produced.



## Flexible automation

The automation devices available (ATA, MVM, AU-TO) combine **productivity** and **flexibility**, both for kit and batch-one production.



## Connectivity 4.0

The proprietary **LINKS** and **OPS** softwares establish communication between the system and the company departments involved in the production flow.



The B3 was designed by combining the features and benefits of **electric** and **hydraulic** press brakes with Salvagnini's in-depth knowledge of **automation, software, mechanics** and **electronics**.

# Maximum availability, maximum productivity.

**OEE is the measure of the total effectiveness of a system.** In traditional press brakes, depending on the production, it can drop to 30%. Even in the case of advanced, precise and fast technologies, manual press brakes are limited by factors such as tooling and set-up times as well as down times for sheet metal feeding, programming, part handling and checking.

## Is it possible to significantly increase the availability of the press brake?

Salvagnini has already done so by introducing a **modular and scalable concept of automation** that can increase the flexibility and independence of the press brake, allowing it to adapt itself in setting up and managing the tools on the basis of what it needs to produce.

**The aim is to make bending an operation that is less influenced by the process variables and, as a result, provides greater certainties, for example, in terms of machining times, as well as costs and budgets.**

Salvagnini has developed 4 automation devices: **ATA** and **ATA.L** automatically adjust the length of the upper and lower tools, **MVM** automatically adapts the die opening, **AU-TO** automatically sets up the tools.

The modularity of these devices allows all Salvagnini's press brakes to be configured to meet actual production requirements, allowing custom intermediate automations to ensure high levels of productivity and efficiency, while at the same time improving the margins on the finished product.



**Regardless of the level of automation chosen from the four available, the B3 remains the solution with the smallest footprint currently available on the market.**

# Scalable automation.

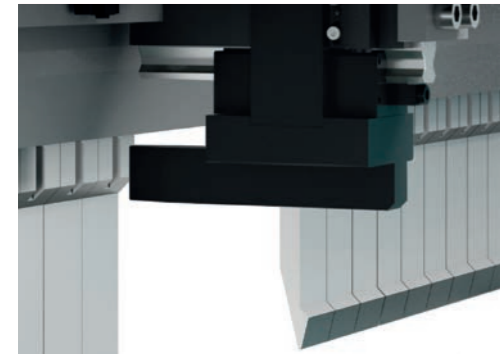

## 1 LEVEL OF AUTOMATION

The **ATA** (Automatic Tool Adjuster) device is used to change and automatically adjust the **upper bending tool** length, saving time and increasing production efficiency. Changeover is fast, taking just a few seconds, and programming is simple and intuitive.

## LEVEL OF AUTOMATION 2

The **ATA.L** device, for the **lower tools**, is the ideal solution for kit production, as it allows parts of different lengths to be bent in sequence.

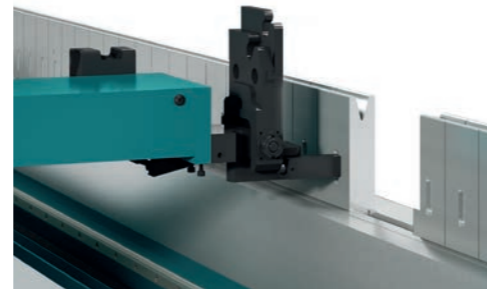

## 3 LEVEL OF AUTOMATION



The **MVM** option, the **variable opening die which is an alternative to ATA.L**, automatically adapts the opening of the V on the basis of the program and allows materials with different thicknesses and/or bending radii to be bent. It does not require manual die set-up, increasing the productivity and flexibility of the press brake.

## LEVEL OF AUTOMATION 4

Salvagnini's **fourth level** of automation is represented by the **AU-TO** automatic tool change device. **AU-TO** does not disable the operation of the **ATA** devices, but rather prepares the machine by maximizing the potential of the automatic tool set-up and applying the best strategies on the basis of the production flow.



# Adaptive technology.

### AMS

**Angle measurement system**  
Laser system that detects variations in the bending angle due to sheet metal springback. Angle measurement can even be performed in a single point, regardless of the length of the press brake, for shorter cycles. It allows measurement recording and active monitoring for greater productivity.



### TFC

**Total frame control**  
Closed-chain control carried out by smart sensors embedded in the press brake structure. If any variations are detected in-cycle, the NC immediately takes corrective action, preventing deviation in the bending angle.



### S-CROWNING

**Adaptive crowning**  
The adaptive mechanical crowning system ensures consistent bending along the entire bending length, even if the parameters change, without operator intervention.

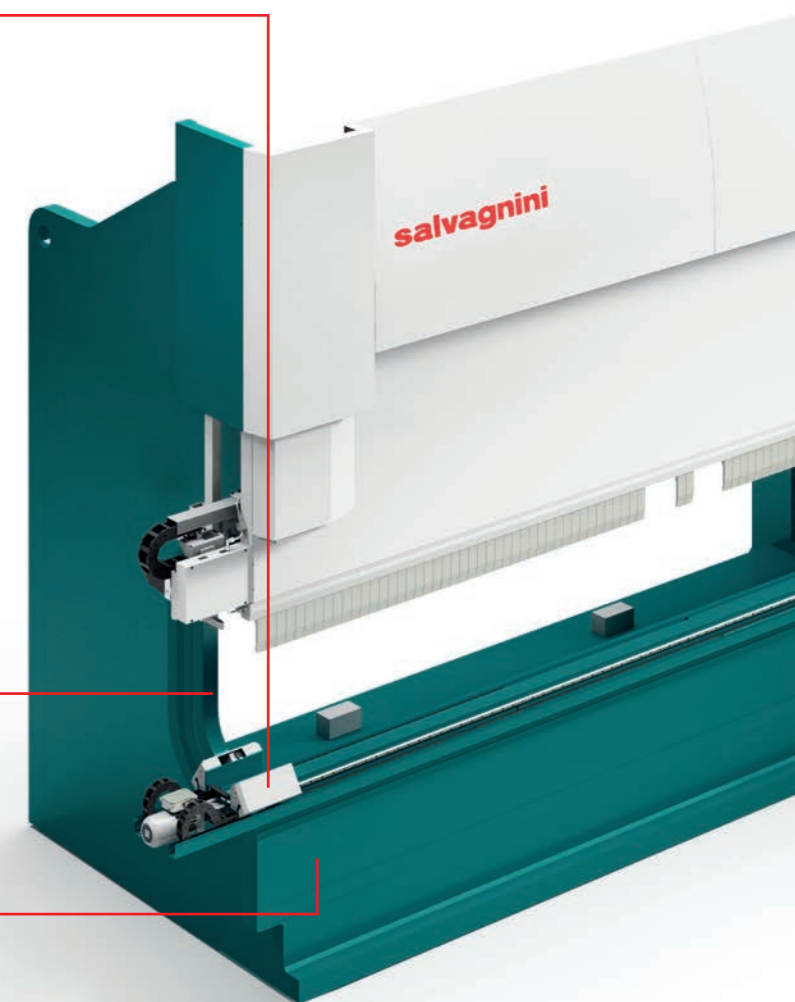

It reduces set-up times and increases the availability of the B3 press brake: the movements occur outside the bending area, and their impact on the added value activities is limited. The tool magazine, **covered** and located in the rear section of the press brake, can hold up to 24 m of tools without requiring any segmentation. The operations are rapid and take place in-cycle and in masked time, contributing to further increasing the efficiency of the technology.

# Sustainable productivity.



### DIRECT DRIVE

#### On-demand consumption

Ram movements are driven by **two independent direct-drive brushless motors**, which allow both fast approach and fast return movements to be achieved, with speeds as high as 250 mm/s.

### KERS

#### Energy recovery system

B3 can be equipped with a **proprietary system** that recovers energy waste and reuses it in subsequent steps, accelerating and reaching higher speeds with the same consumption.

### LSB safety system

This is composed of a laser transmitter and HD camera for detecting objects in the danger zone. It is able to **reduce the speed-change position** to as little as 2 mm from the sheet of metal.

### LED lighting

Two sets of LED lights are installed in the upper and inner sections of the press brake to illuminate the work area and the backgauges, and guarantee suitable visibility during the operating cycles, while keeping power consumption down and preventing undesirable heating due to heat emissions in the work area.

# Connectivity 4.0



This is the software which provides an accurate **estimation of production costs**. It allows calculation not only on the basis of the individual technology, but also over the entire process, including upstream and downstream machining where necessary.

This is the modular software which optimizes the entire **production process** and allows it to be controlled through interaction with the management software and **ERP/MRP** inside and outside the factory.

LINKS is Salvagnini's IoT solution that monitors the **performance of the the press brake**. It offers access to production data, logbooks, performance KPIs and telemetry, as well as parameter monitoring by the Condition Monitoring process, thus increasing the overall equipment efficiency.



# Standard equipment at your service.

**+** FACE is Salvagnini's simple and intuitive new human-machine interface, which minimizes the operational complexity of the press brake.

- It includes functions such as real-time 3D integrated simulation, graphical tools and barcodes.
- It incorporates EasyData2.0, the interactive diagnostics application.
- It is a multi-touch device.
- It works in a single window, eliminating background operations.



## Backgauges

Available in four different types, for **maximum production flexibility**. Each backgauge comprises an extremely rigid ram. All axes slide on linear guides to guarantee accuracy and sturdiness.

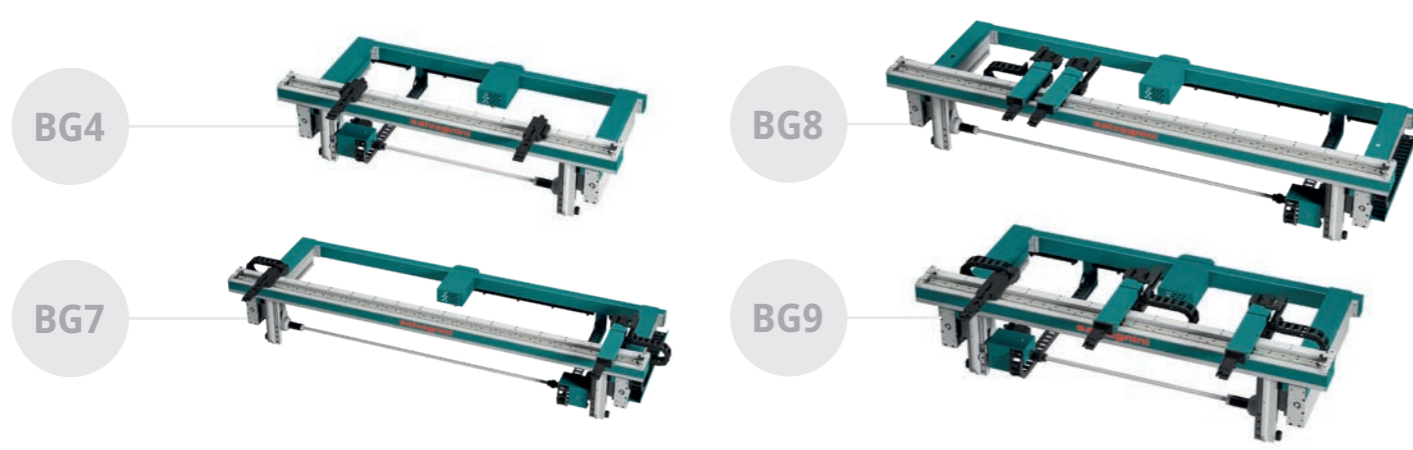

## Optional equipment

### STL lighting

The STL LED system is available on request. This is installed on the upper tool clamp to guide the operator in setting up the press brake or during the bending phases.

### FLW sheet follower

The FLW sheet follower is recommended for bending particularly large or heavy pieces. Each FLW has a maximum capacity of 150 kg and is pushed along a linear guide. They are equipped with maneuvering devices to move toward the support surface bend line and to change the vertical position, up to a 60° angle.



## Sliding doors

Attached to the press brake structure, they allow **easy handling of tools and workpieces**, without increasing the machine's footprint.

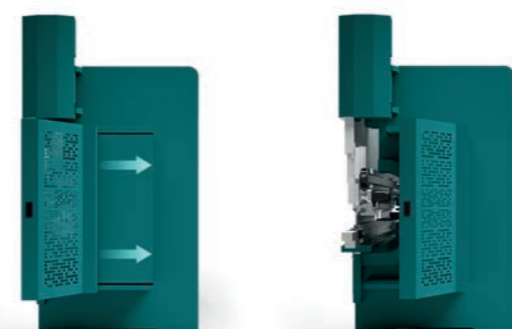

## Front sliding shelves

Pair of front sliding shelves with capacity of **120 kg** that support the sheet of metal being machined. They guarantee ergonomic use and ease of handling for the workpieces.

# Solutions for all production requirements.



**B3**  
Compact technology

**B3 ATA**  
Productivity and flexibility



**B3 AU-TO**  
The adaptive press brake



The B3 press brake can easily be integrated into systems, flexible cells or automated factories to meet all automation needs.

- 1 **MAIN FEATURE:**  
robotic bending
- 2 **TARGET MARKET:**  
wide
- 3 **TYPICAL APPLICATION AREA:**  
medium batches
- 4 **APPLICATION SECTOR:**  
job shops, electrical industry, ...
- 5 **MACRO ADVANTAGES:**  
repeatability for serial production

**ROBOformer** is the automatic solution for unmanned production with Salvagnini press brakes. It combines the dynamics of a press brake with the capabilities of a robot arm, managing each activity completely independently.



# Multiprocess solutions for automatic bending.



**Frame Bender** is the automatic bending solution achieved by integrating a panel bending system with a press brake, both employing dedicated robots to handle WIP parts and connected to automatic devices.

- 1 **MAIN FEATURE:**  
in-line bending
- 2 **TARGET MARKET:**  
medium
- 3 **TYPICAL APPLICATION AREA:**  
production of families of parts
- 4 **APPLICATION SECTOR:**  
doors, profiles
- 5 **MACRO ADVANTAGES:**  
speed and repeatability

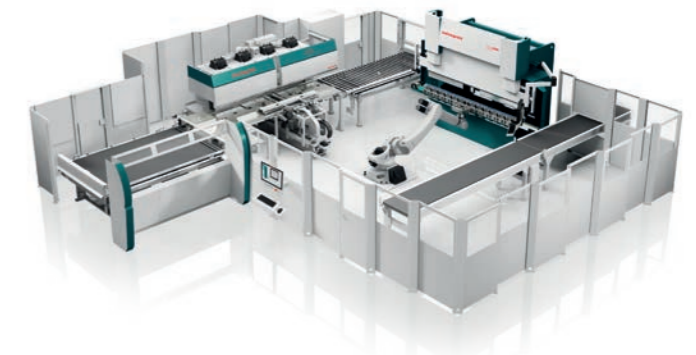

- 1 **MAIN FEATURE:**  
flexible bending cell
- 2 **TARGET MARKET:**  
very wide
- 3 **TYPICAL APPLICATION AREA:**  
medium/small batches
- 4 **APPLICATION SECTOR:**  
OEM (HVAC, catering, switchboards, ...)
- 5 **MACRO ADVANTAGES:**  
flexibility, optimized times and costs

**FlexCell:** combination of stand-alone machines communicating with one another thanks to the proprietary processing software. This unique solution allows **maximum value to be obtained from the bending operation** by combining panel bender productivity with press brake flexibility. It can be easily integrated with automatic handling devices for 4.0 factories.

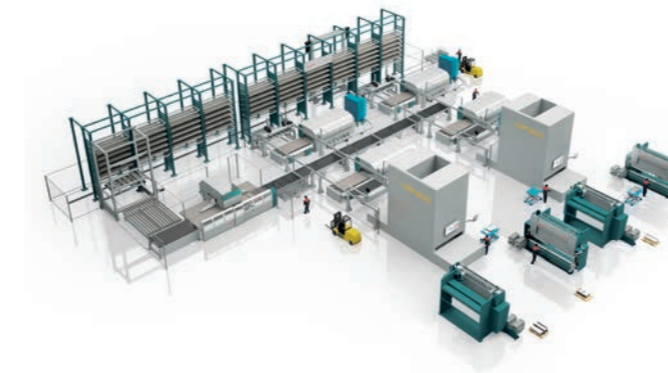

**AJS** is Salvagnini's 4.0 multi-process solution: by combining different production technologies and managing operations via the proprietary OPS software, it schedules, balances and optimizes factory production flows in a completely automatic and flexible manner.

- 1 **MAIN FEATURE:**  
lights-out manufacturing
- 2 **TARGET MARKET:**  
low
- 3 **TYPICAL APPLICATION AREA:**  
mass production
- 4 **APPLICATION SECTOR:**  
OEM
- 5 **MACRO ADVANTAGES:**  
automation, factory 4.0

# Unbeatable stroke.

Salvagnini offers a wide range of models, with strokes of **300 to 450 mm** according to size, to meet all production requirements and maximize the use of the press brake.

TECHNICAL DATA	60/2000	100/3000	135/3000	135/4250	170/3000	170/4250	170/4250XL	220/3000	220/4250	220/5100	220/6100	320/3000	320/4250	320/5100	400/4250	AU-TO 170/4250	AU-TO 220/4250
Maximum bending force [Tons]	60	100	135	135	170	170	170	220	220	220	220	320	320	320	400	170	220
Table length <b>L</b> [mm]	2040	3060	3060	4250	3060	4250	4250	3060	4250	5100	6100	3060	4250	5100	4250	4250**	4250
Distance between side frames <b>I</b> [mm]	1740	2640	2640	3640	2640	3640	3620	2650	3620	4620	5600	2630	3600	4600	3600	3640	3620
Throat depth <b>TD</b> [mm]	350	435	435	435	435	435	520	520	520	520	520	520	520	520	520	435	520
Maximum speed [mm/s]	250	250	250	250	250	250	220	220	220	220	180	220	220	220	220	250	220
Bending speed* [mm/s]	20	20	20	20	20	20	18	18	18	18	18	18	18	18	18	20	18
Maximum stroke [mm]	300	300	350	350	350	350	450	450	450	450	450	450	450	450	450	350	450
Table-ram distance <b>OH</b> [mm]	550	550	600	600	600	600	700	700	700	700	700	700	700	700	700	600	700
Total length <b>B</b> [mm]	3200	4270	4310	5310	4310	5310	5330	4360	5330	6330	7400	4380	5350	6350	5350	5560	5560
Total width <b>P</b> [mm]	1875	1725	1735	1735	1735	1735	2080	2080	2080	2080	2080	2085	2085	2085	2085	2170	2240
Total height <b>H</b> [mm]	3025	3025	3295	3295	3295	3295	3705	3705	3705	3705	3705	3755	3755	3755	3755	3290	3690
Maximum electrical consumption [kW]	10	12	16	16	20	20	20	26	26	26	26	39	39	39	45	20	26
Mass [kg]	6200	8600	11700	13500	11700	13500	19400	17000	19400	21500	23500	21800	25000	30000	27000	15500	21600

\* Bending speed regulated by current standards. Salvagnini reserves the right to modify this data without prior notice.

\*\* automatic tools set up L = 3060 mm

